

CONCRETE BUCKETS

Concrete bucket with riding platform

CT-P Model

Concrete bucket with man platform

Opening by lever

Supplied with a flexible rubber hose 2 mt length

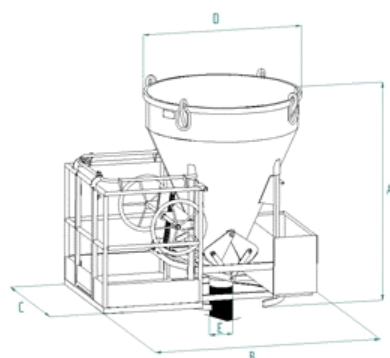

MODEL	CAP.(Lt)	DIMENSIONS (mm)					CAP. (kg)	WEIGHT (kg)
		A	B	C	D	E		
CT-50P	500	1250	1930	1200	1050	200	1300	200
CT-80P	800	1490	1930	1200	1250	200	2080	300
CT-99P	1000	1802	1930	1200	1350	200	2600	320
CT-150P	1500	2182	1930	1200	1350	200	3900	440
CT-200P	2000	2480	1930	1200	1350	200	5200	560
CT-250P	2500	1904	1930	1200	1884	200	6500	680
CT-300P	3000	2180	1930	1200	1884	200	7800	800